

**G A M E  R E A D Y®**

**GRPro® 2.1 CONTROL UNIT  
User's Manual**

---

**MODEL NUMBERS**

**550550-03, 550550-03-RN, 550550-53**

This User's Manual can be found online in various languages at  
[www.gameready.com](http://www.gameready.com)

دليل المستخدم هذا متوفر بلغات عدة على الموقع الإلكتروني  
[www.gameready.com](http://www.gameready.com)

Dieses Betriebshandbuch ist in verschiedenen Sprachen online unter  
[www.gameready.com](http://www.gameready.com) verfügbar

Este Manual del usuario está disponible en [www.gameready.com](http://www.gameready.com) en distintos idiomas

可前往在线获得本用户手册的多种语言版本  
[www.gameready.com](http://www.gameready.com)

Denne brugervejledning kan findes online på forskellige sprog på [www.gameready.com](http://www.gameready.com)

Deze Gebruikershandleiding is online beschikbaar in verschillende talen op  
[www.gameready.com](http://www.gameready.com)

Tämä käyttöopas löytyy netistä eri kielillä: [www.gameready.com](http://www.gameready.com)

On peut trouver ce manuel de l'utilisateur dans plusieurs langues en ligne à  
[www.gameready.com](http://www.gameready.com)

Μπορείτε να βρείτε αυτό το Εγχειρίδιο Χρήσης σε ηλεκτρονική μορφή σε διάφορες γλώσσες  
στη διεύθυνση: [www.gameready.com](http://www.gameready.com)

[www.gameready.com](http://www.gameready.com) ניתן למצוא את המדריך הזה למשתמש בשפות שונות באתר

Questo Manuale per l'utente è disponibile online in varie lingue su [www.gameready.com](http://www.gameready.com)

本ユーザー・マニュアルは、[www.gameready.com](http://www.gameready.com)  
へ行けば様々な言語でオンライン閲覧できます。

[www.gameready.com](http://www.gameready.com)

에 가시면 이 사용자 설명서를 온라인에서 다양한 언어로 찾아보실 수 있습니다.

Niniejszą Instrukcję obsługi można znaleźć w internecie w różnych językach na stronie  
[www.gameready.com](http://www.gameready.com)

Este Manual do Usuário pode ser encontrado online em vários idiomas em  
[www.gameready.com](http://www.gameready.com)

Данную инструкцию по применению, а также ее переводы на различные языки,  
можно найти на веб-сайте [www.gameready.com](http://www.gameready.com)

Denna användarhandbok finns tillgänglig på olika språk på nätet via  
[www.gameready.com](http://www.gameready.com)

Bu Kullanıcı Kılavuzu, değişik dillerde çevrimiçi olarak [www.gameready.com](http://www.gameready.com)  
adresinde bulunmaktadır

## TABLE OF CONTENTS

Introduction to Game Ready .....	2
Detailed Instructions for Use .....	4
Modes of Operation .....	5
Buttons.....	5
Adjusting Temperature.....	6
Display .....	6
Operating the System.....	8
Storage .....	12
Cleaning .....	12
Maintenance .....	14
Accessories .....	15
Indications for Use.....	15
Contraindications .....	15
General Warnings and Cautions.....	16
Specifications.....	17
UL Classification .....	18
Electromagnetic Compatibility .....	19
Troubleshooting .....	24
Warranty .....	27
Warranty Registration .....	28

## INTRODUCTION TO GAME READY

Based in Concord, California, and founded in 1997, Game Ready® (CoolSystems, Inc.) is a best-in-class sports medicine and orthopedic medical device that helps athletes and patients recover from injury or orthopedic surgery.

The Game Ready System with ACCEL® Technology gives healthcare providers the power to accelerate the body's natural repair mechanisms, setting a new standard in injury and post-op recovery.

Comprised of a control unit featuring proprietary ACCEL Technology (Active Compression and Cold Exchange Loop) and a complete range of dual-action Wraps designed for each body part, the revolutionary system uniquely integrates active compression and cold therapies to accelerate natural healing.

Immediately after suffering a musculoskeletal injury, the body initiates a series of physiological responses to defend surrounding tissues and begins to repair the damage. While inflammation is a natural and necessary mechanism in this process, controlling it effectively can actually allow the body to enter the later stages of healing faster. Until now, the RICE (Rest-Ice-Compression-Elevation) principles have been used to passively control symptoms, moderating pain and swelling. Going beyond static cold and compression applications, Game Ready with ACCEL Technology proactively aids lymphatic function, encourages cellular oxygen supply, and stimulates tissue repair.

### REGISTER YOUR PRODUCT

Please complete your Warranty Registration within 30 days for both the GRPro® 2.1 Control Unit and the Wraps online at [www.gameready.com](http://www.gameready.com). A Wrap registration card is packaged with each Wrap. Further warranty information can be found in the Warranty Section of this manual.

### DON'T JUST TREAT SYMPTOMS, HELP ACCELERATE HEALING

We'd enjoy hearing from you. If you have questions, want to learn more, or wish to share your experience with the Game Ready System, please call us at 1.888.426.3732, or email us at [info@gameready.com](mailto:info@gameready.com).

1.888.GameReady (1.888.426.3732)

[www.gameready.com](http://www.gameready.com)









**CAUTION:** United States Federal law restricts this device to sale by or on the order of a licensed healthcare practitioner.

**WARNING:** Follow the recommendations of your health care practitioner regarding the frequency and duration of use. Improper placement or prolonged use of the GRPro 2.1 could result in tissue damage. Discontinue use immediately if you experience burning, itching or increased pain and swelling. Monitor the skin receiving cold therapy frequently and discontinue use if changes such as blisters, increased redness, discoloration or welts occur.



**IMPORTANT: READ COMPLETE INDICATIONS, CONTRAINDICATIONS, CAUTIONS AND WARNINGS BEFORE USING THIS PRODUCT!**



	Game Ready System as to electrical shock, fire and mechanical hazards only in accordance with EN 60601-1:2006 + A1:2013, IEC 60601-1:2012, IEC 60601-1-6:2010(3rd Ed.) + A1:2013, IEC 60601-1-11:2010 and ANSI/AAMI ES60601-1:2005(R)2012.
	Powered by Direct Current
	Type BF Applied Parts
	Warning: It is mandatory to fully read and understand the Instructions for Use before using the device. Failure to follow operating instructions could result in serious injury.
	Attention: Consult Instructions for Use
	Manufacturer
	Symbol for "made in" a specific country (XXXX)
	Symbol for "assembled in" a specific country (XXXX)

## DETAILED INSTRUCTIONS FOR USE

Users are required to read this User's Manual in full prior to using this device.

Do not use this device without your physician's specific recommendations for the frequency and duration of your treatments.

The most common recommendation is to use cold therapy at least 4 times a day, for approximately 30 minutes each time, with at least a 30-minute break between treatments.

While the temperature is adjustable, it is reported that the greatest benefit from cold therapy is in the 40-60°F (4.5-15.5°C) temperature range.

Generally reported compression recommendations are for "None" to "Low" pressure settings during the first 24-48 hours after surgery or injury, increasing to "Medium" or "High" only if it is comfortable after the first 48 hours.

We recommend that "High" pressure is never applied if you are confined to bed.

## MODES OF OPERATION









**Manual Mode:** The system automatically starts in this mode, and allows the user to adjust treatment time and pressure settings.

**Program Mode:** This mode allows the user to choose one of six treatment programs that provide therapy for a set time then sleep (no treatment) for a set time, continuously, at a specific pressure setting.

**Drain Mode:** Allows a user to connect a Hose with a special Hose Adapter (purchased separately) to the unit, enter Drain Mode and have the unit empty the water out of the ice box through the Hose. Drain Mode can be accessed by pressing the program key and toggling through all six programs. To empty water in the system while in Drain Mode, press the program key until you reach Drain Mode, attach the Hose Adapter to the Connector Hose, place the Hose Adapter over a sink, and press the Play button. Drain Mode will run the Control Unit's fluid pump for up to six minutes (long enough to fully empty the ice box). Drain Mode is indicated by the following icons:



## BUTTONS













	<b>Power:</b> Use this button to turn the Control Unit on and off.
	<b>Program:</b> Use this button to select one of the available Programs or to return to Manual Mode. See page 11 in this manual for more information on Programs.
	<b>Play/Pause:</b> Use this button to start or pause a treatment.
	<b>Add Time:</b> Use this button to add time in Manual Mode (does not work in Program Mode). You can add up to 90 minutes. Treatment must be paused in order to add or subtract time.
	<b>Subtract Time:</b> Use this button to reduce time in Manual Mode (does not work in Program Mode). You can subtract up to 90 minutes. Treatment must be paused in order to add or subtract time.
	<b>Pressure Selection:</b> Use this button to select one of four pressure settings: No Pressure, Low Pressure (5-15 mmHg), Medium Pressure (5-50 mmHg), and High Pressure (5-75 mmHg). Pressure selection is not available in Program Mode. Treatment must be paused to change pressure settings.
	<b>Volume:</b> Use this button to select the option of sound or no sound. Push to mute sound. Alarms will still sound even with Volume off.
	<b>C/F Button:</b> Use this button to select either Celsius or Fahrenheit on the temperature display.
	<b>Backlight:</b> Use this button to turn the backlight on or off.

## ADJUSTING TEMPERATURE

To adjust the temperature being applied during treatment, simply turn the temperature knob towards 3 snowflakes for the maximum amount of cold, or towards 1 snowflake for the least amount of cold. Notice that as you adjust the knob, the “Target Temperature” on the display will change. The system will automatically adjust to match the temperature you have selected.

**TIP:** The maximum amount of cold is dictated by the amount of ice in the reservoir and the setting of the temperature adjustment knob. You may need to stir or replenish the ice to achieve coldest temperatures. Ice will melt faster in the acute phases of injury as the Game Ready System is removing greater amounts of heat from the treatment site.

## DISPLAY

<p><b>Status bar:</b></p> <p>Vol </p> <p>Manual Program </p> <p>Pause </p> <p>Play </p>	<p>Vol </p> <p>Manual Program </p> <p>Pause </p> <p>Play </p>	<p>Off (Mute)</p> <p>On</p> <p>Indicates selected mode.</p> <p>Indicates unit is paused.</p> <p>Indicates unit is running.</p>
<p><b>Other Icons:</b></p>	<p>Error </p> <p>Sleep </p> <p>Battery </p>	<p>Indicates an error. See troubleshooting pages 24-26 for error codes.</p> <p>Indicates sleep mode time.</p> <p>Indicates remaining battery capacity.</p>
<p><b>Temperature:</b></p>	 	<p><b>Actual Temperature:</b> Approximate temperature of the water leaving the Control Unit.</p> <p><b>Target Temperature:</b> Indicates the target temperature setting. The Control Unit will automatically match the Actual Temperature and Target Temperature as closely as possible.</p>



**When the system is running in Program Mode:**



Sleep time count-down bars.

Displays the amount of run time remaining.

Run time count-down bars.

Displays the amount of sleep time remaining.

**When the system is running in Manual Mode:**



Displays the amount of run time remaining.

**When selecting a program:**

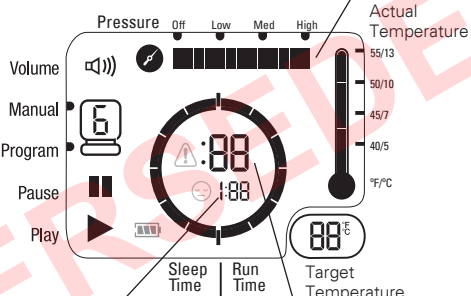

Displays pressure.

Actual Temperature

55/13  
50/10  
45/7  
40/5  
°F/°C

Volume

Manual 6

Program 6

Pause

Play

Sleep Time | Run Time

Target Temperature

88°C

Displays amount of time unit will sleep.

Displays amount of time unit will run.

**Pressure:**

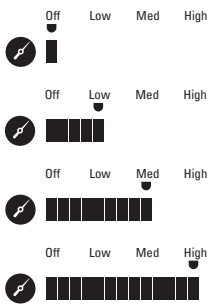

Off Low Med High

Off Low Med High

Off Low Med High

Off Low Med High

## OPERATING THE SYSTEM

### To operate your GRPro 2.1 System, you need:

- Control Unit filled with ice and water as indicated by the fill line labels within the reservoir. Optimal performance is achieved by first adding 1.5 liters of water, and then filling the reservoir to the top with ice.
- Game Ready supplied power supply.
- Connector Hose.
- Wrap (includes a Heat Exchanger and Sleeve).

### Notes:

- The Wrap is comprised of an inner Heat Exchanger and an outer Sleeve. The combination of Sleeve and Heat Exchanger is referred to throughout this manual as a "Wrap." To ensure proper performance, be sure to use ATX Series Heat Exchangers.
- The Control Unit should be placed on a stable surface (such as the floor or a table) during use.
- Note that using the system in an environment with a high ambient temperature may affect its ability to provide adequate cooling, or may limit the ice life.
- If you will be using the system with a Game Ready optional battery pack (sold separately), please consult the instructions for use that accompany that battery pack.

### Warning:

- Your GRPro 2.1 Control Unit should be plugged into a grounded electrical outlet prior to operation when using the FSP Power Supply. When using the Mega MDM-030-A120-5396 power supply, a grounded electrical outlet is not required.
- Position the Control Unit to minimize the risk of tripping over the Control Unit, Connector Hose, or power cord.

### Precautions:

- Failure to properly follow the instructions of this manual and those of your medical provider may interfere with or prevent delivery of appropriate therapy.
- To avoid risk of electrical shock unplug the Control Unit from the electrical outlet prior to filling the Control Unit with ice and water.

- 1 Push the door release button to open the ice box door.

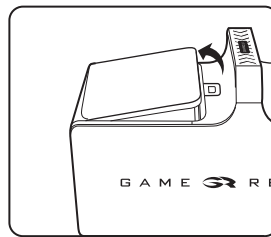
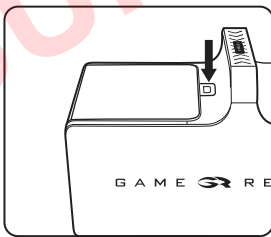

- 2 Add water to fill-line indicated on label within the reservoir. DO NOT OVERFILL. Add ice to top of reservoir.

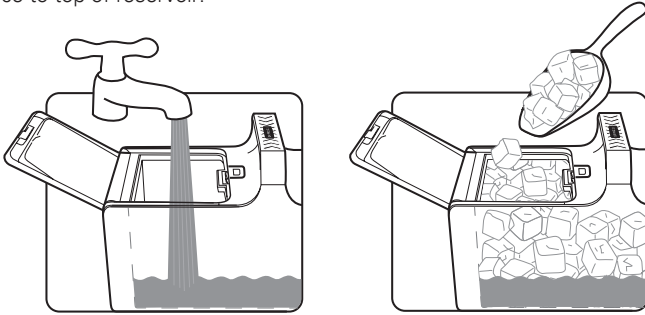

- 3 Close the ice box door. Make sure you hear it click.

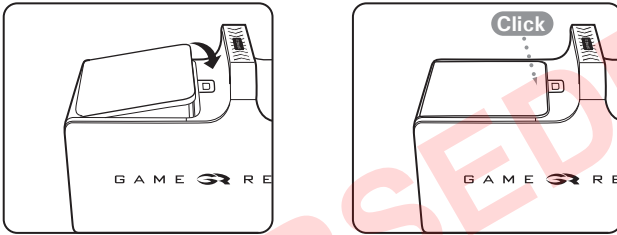

- 4 Place the Control Unit in the location where you plan to use it. The Control Unit should only be used in the upright orientation as shown. The Control Unit will leak if placed on its side.

- 5 Connect the AC Adapter to the receptacle on the end panel of the Control Unit, then plug the AC Adapter into an electrical outlet. The power indicator light (orange color) on the Control Unit should illuminate. Press the power button.  The screen should light up and the Control Unit should beep twice. The power indicator light should turn from orange to green. If you do not see these indicators, refer to "Control Unit will not turn on" on page 26 of the Troubleshooting Guide in this manual.

**Note:** The Control Unit should be turned on prior to attaching a Wrap.

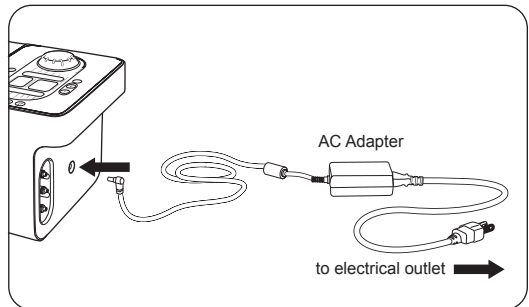

- 6 Connect the larger end of the Connector Hose (with the red button) to the Control Unit. Make sure you hear it click. To disconnect, simply press the red button and remove the connector from the Control Unit.

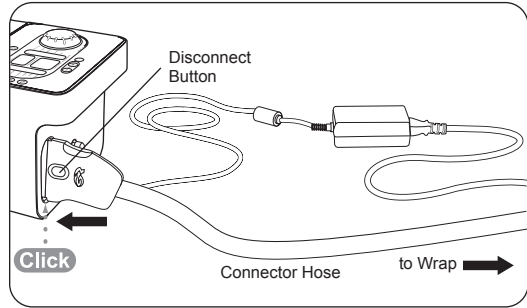

- 7 Apply the selected Wrap (consult the Use Guide accompanying each Wrap for application instructions). To ensure proper performance of the system, it is important to use ATX Series Heat Exchangers in your Wrap.

**Caution:**

- The Wrap is not sterile. Do not place directly against open wounds, sores, rashes, infections, or stitches. The Wrap may be applied over clothing or dressing.
- To ensure best fit, be sure the Wrap is completely deflated prior to each application.

- 8 Connect the smaller end of the Connector Hose (with a blue or gray button) to the Wrap. Make sure you hear it click. To disconnect, simply press the blue or gray button and remove the connector from the Wrap.

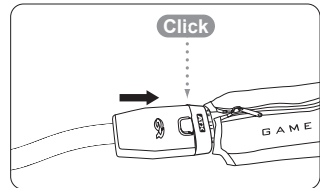
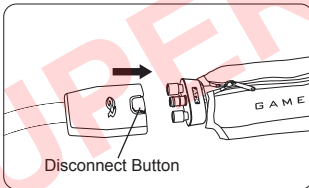



If you have any problems with the set-up of your GRPro 2.1 System, in the U.S. call Game Ready Customer Service at 1.888.426.3732 (+1.510.868.2100); from outside of the U.S. please contact your local distributor.

**Warnings:**



- Follow the treatment recommendations of your health care practitioner for the use of this device.
- Improper placement or prolonged use of the GRPro 2.1 could result in tissue damage.
- READ COMPLETE INDICATIONS, CONTRAINDICATIONS, CAUTIONS AND WARNINGS BEFORE USING THIS PRODUCT!

- 9** Manual ▶  Select the operating mode. You can choose either Manual Mode or Program Mode. Manual Mode allows you to customize the time and pressure settings. Program Mode allows you to select one of six automated programs that provide treatment for a set time interval then “sleep” (providing no treatment) for a set time, continuously, at a specific pressure setting (refer to list of available programs below). The unit automatically starts in Manual Mode.

**Manual Mode:**

	Set the time in five minute increments by pushing the +/- buttons.
	Set the pressure by pushing the pressure button. You can select from 4 pressure settings: No pressure, Low Pressure (5-15mmHg), (Medium Pressure (5-50mmHg), High Pressure (5-75mmHg).

**Program Mode:**

	Push the program button to enter Program Mode. In Program Mode, the unit will operate continuously according to the selected program. You will need to replenish ice and water as previously indicated in step 2.
	<p>You can select from the following programs: (Push the Program Button to scroll through the available programs.)</p> <p><b>Program 1:</b> 30 minutes on, 30 minutes sleep. No pressure.</p> <p><b>Program 2:</b> 30 minutes on, 30 minutes sleep. Low pressure.</p> <p><b>Program 3:</b> 30 minutes on, 30 minutes sleep. Medium pressure.</p> <p><b>Program 4:</b> 30 minutes on, 60 minutes sleep. No pressure.</p> <p><b>Program 5:</b> 30 minutes on, 60 minutes sleep. Low pressure.</p> <p><b>Program 6:</b> 30 minutes on, 60 minutes sleep. Medium pressure.</p> <p><b>Program d:</b> Drain Mode. Please refer to page 5 in this manual for details.</p>

- 10**  Press play/pause button to start your Game Ready treatment with ACCEL Technology. Press play/pause at any time to stop your treatment.

- 11** Set to your target temperature (displayed in the Target Temperature window) by turning the knob. For coldest therapy, turn the knob clockwise towards three snowflakes. For warmer therapy, turn the knob counter-clockwise towards one snowflake.



- 12** Replenish ice and water levels as necessary, and indicated in Step 2, to maintain your target temperature.

- 13** After use:

- Unplug the AC Adapter and the Connector Hose from the Control Unit
- Push the door release button to open the door
- Carefully pour out the ice and water
- Wipe off any excess water

## STORAGE

When you are done using the system for the day:

- Unplug the AC Adapter and the Connector Hose from the Control Unit.
- Push the door release button to open the door.
- Carefully pour out the ice and water.
- Wipe off any excess water.
- Store the Control Unit with the lid fully open to allow the interior to dry and preserve the reservoir seal. Store the Control Unit in the Carry Bag or in another safe location. Remember that your GRPro 2.1 Control Unit is a valuable piece of equipment and should be treated with great care, like a laptop computer.

System Storage Temperature: 33° - 120°F (1° - 50°C)

Relative Humidity: 10% - 95% non-condensing

**Caution:** Do not keep in extreme cold or hot temperatures (below 33°F or above 120°F or below 1° or above 50°C). Do not leave in a hot or freezing car. Do not leave the Control Unit in direct sunlight. The UV light may damage or discolor the Control Unit.

## CLEANING

### SYSTEM

If desired, the system (Control Unit, Hoses, and Wraps) can be flushed with a mixture of isopropyl alcohol and water, and run on no compression ("off"). This should be followed by running the Control Unit with clean water only on the no compression ("off") setting.

### CONTROL UNIT

The exterior of the Control Unit and the visible interior surfaces of the reservoir can be cleaned with a soft cloth and one of the following cleaning agents:

- Mild detergent
- 70% Isopropyl alcohol
- Antifect® FF
- Mikrozid® Sensitive Wipes
- Quaternary ammonium (such as Virex® – typically only found in a clinical use setting)
- Cavicide®

#### **Procedure:**

- Follow the manufacturer's instructions and precautions for the cleaning agent you select.
- Apply the selected cleaner to a soft cloth and wipe down all surfaces of the Control Unit.
- Allow the Control Unit to dry thoroughly before storing it in the bag.
- The Control Unit should be cleaned as needed.

#### **DO NOT USE:**

- Phenolic-based disinfectants (such as AmphyI® – typically only found in a clinical use setting).
- Any solvent-based cleaners on the Control Unit. Doing so will damage the plastics and will void your warranty.
- Abrasive materials to clean the Control Unit. Doing so will damage the plastics and will void your warranty.

**Caution:** The Control Unit is not a waterproof device. Do not apply a direct stream of any liquid onto the Control Unit, submerge the Control Unit, or allow any liquid to pool on the surface of the front panel of the Control Unit.

## CONNECTOR HOSE

The surface of the Connector Hose can be cleaned using a soft cloth and one of the following:

- Mild detergent
- Steri-Fab®
- Antifect® FF
- Mikroizid® Sensitive Wipes
- 70% Isopropyl alcohol
- We do not recommend the use of quaternary ammonium (such as Virex®) or Cavicide®

### DO NOT USE:

- Phenolic-based disinfectants (such as Amphyl® – typically only found in a clinical use setting).
- Any solvent based cleaners. Doing so will damage the plastics and will void your warranty.
- Abrasive materials. Doing so will damage the plastics and will void your warranty.
- Any petroleum based lubricants. Doing so will damage the o-rings and will void your warranty. If lubrication is required, the use of silicon spray is recommended.

## WRAPS

Gently remove Heat Exchanger from the Sleeve. Hand wash the Sleeve in cold water, using a mild detergent or antibacterial soap. Do not use fabric softener. Hang to dry.

If needed, the external surface of the Heat Exchanger may be cleaned by wiping down with commercial non-bleach cleaning wipes or hand washed using a very small amount of mild detergent or antibacterial soap. DO NOT MACHINE WASH.

Refer to the Wrap Use Guide accompanying individual Wraps for more information.

## CARRY BAG

The Carry Bag should be cleaned using a soft cloth or brush and a mild detergent. Febreze® or the equivalent can be used on the Bag if desired. If the Carry Bag has a biological material on the surface, Steri-Fab® may be used to decontaminate those surfaces.

Be sure to test any product on a small portion of the Bag to ensure that it will not cause damage.

**Note:** To operate the GRPro 2.1 System, you do not need to remove it from the Carry Bag. Simply unzip the Bag's main compartment and end panel. Fill the reservoir with ice and water. Attach the Connector Hose and the AC Adapter to the end panel of the Control Unit and plug the AC Adapter into an electrical outlet.

## MAINTENANCE

The reservoir filter should be inspected, cleaned, and/or replaced as necessary.

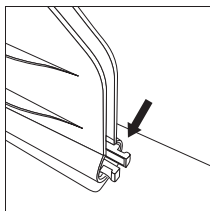

- 1** Identify the filter within the ice reservoir.

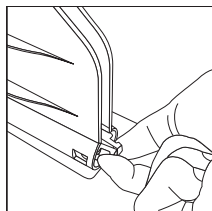

- 2** Using two fingers, grasp and squeeze the two protruding prongs.

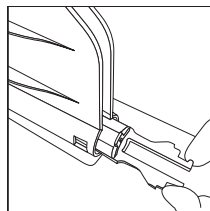

- 3** Slide the filter out.

- 4** Rinse debris from the filter and be sure there are no obvious signs of damage.

If you have questions or would like to order a new filter, in the U.S. call Game Ready Customer Service at 1.888.426.3732 (+1.510.868.2100); from outside of the U.S. please contact your local distributor.

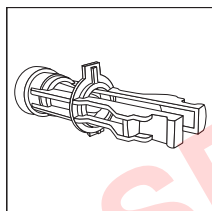

- 5** To replace the filter, or install a new filter, first ensure that the filter is oriented properly with the plastic tab facing up. If the filter is not oriented properly, the protruding tab will prevent the filter from sliding back into place.

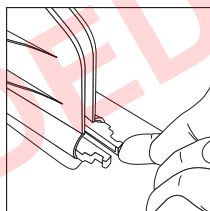

- 6** You will feel and hear the filter snap back into place.

Other than maintaining the reservoir filter, no product service or modification should be performed by the user. If your GRPro 2.1 System requires service, in the U.S. call Game Ready Customer Service at 1.888.426.3732 (+1.510.868.2100); from outside of the U.S. please contact your local distributor.



## ACCESSORIES

The GRPro 2.1 Control Unit can be used with any of the following accessories:

- Any Game Ready Wrap using ATX Series Heat Exchangers (wraps made by any other manufacturer CANNOT be used with this system)
- Game Ready supplied FSP Group, Inc. Power Supply model FSP 030-RCAM and Hospital Grade Power Cord or Mega MDM-030-A120-5396 power supply
- Game Ready supplied Connector Hose
- Game Ready Carry Bag
- Game Ready Drain Mode Adapter
- Game Ready Rechargeable Battery Pack

If long storage of the Battery Pack is required, it is recommended that the battery is periodically recharged to preserve the electronic integrity of the battery. Fully charge before use and every six (6) months.

## INDICATIONS FOR USE

**Caution: United States Federal Law restricts this device to sale by or on the order of a licensed health care practitioner.**

- **Follow the treatment recommendations of your health care practitioner for duration and frequency of use for this device.**

The GRPro 2.1 System combines cold and compression therapies. It is intended to treat post-surgical and acute injuries to reduce edema, swelling, and pain for which cold and compression are indicated. It is intended to be used by or on the order of licensed healthcare professionals in hospitals, outpatient clinics, athletic training settings, or home settings.

## CONTRAINDICATIONS

Important: Read the Wrap Use Guide for Wrap specific contraindications and warnings.

**Compression Therapy using the Game Ready System or any compression therapy device should not be used in patients:**

- Who are in the acute stages of inflammatory phlebitis in the affected region.
- Who have any current clinical signs suggestive of deep vein thrombosis in the affected region.
- Who have significant arteriosclerosis or other vascular ischemic disease in the affected region.
- Who have any significant risk factors or current clinical signs of embolism (e.g. pulmonary embolus, cerebral infraction, atrial fibrillation, endocarditis, myocardial infarction, or arteromatous embolic plaque).
- Who have a condition in which increased venous or lymphatic return is not desired in the affected extremity (e.g., carcinoma).
- Who have decompensated hypertonia in the affected region.

**Cryotherapy using the Game Ready System or any cryotherapy device should not be used in patients:**

- Who have significant vascular impairment in the affected region (e.g., from prior frostbite, diabetes, arteriosclerosis or ischemia).
- Who have known hematological dyscrasias which affect thrombosis (e.g., paroxysmal cold hemoglobinuria, cryoglobulinemia, sickle-cell disease, serum cold agglutinins).

## GENERAL WARNINGS AND CAUTIONS

### WARNINGS

- Follow the treatment recommendations of your health care practitioner for duration and frequency of use for this device.
- Improper placement or prolonged use of the Game Ready System could result in tissue damage.
- Use extra caution during the immediate postoperative period, especially when sedated or on any medication that could alter normal pain sensation. Check the skin of the treated region frequently and use mid-to-higher (warmer) temperature range settings or leave more time between treatments, if necessary.
- A layer of clothing between Wrap and skin is recommended for all patients.
- During the course of therapy, patients should monitor the skin of the treated region, the surrounding area and the digits of the extremities of the treated limb (if applicable) for any burning, itching, increased swelling, or pain. If any of these signs are present, or any changes in skin appearance occur (such as blisters, increased redness, discoloration, or other noticeable skin changes), patients are advised to discontinue use and consult a physician.
- Game Ready Wraps are not sterile; do not place directly against open wounds, sores, rashes, infections, or stitches. The Wrap may be applied over clothing or dressing.
- Game Ready Wraps are available in multiple configurations but are not intended for all possible physiological uses. For example, the Ankle Wrap is not designed for use on the toes and the Back Wrap is not designed for use in the abdominal region.

#### **Compression Therapy with the Game Ready System should be used only under the supervision of a licensed healthcare practitioner in patients:**

- Who have an open wound in the affected region (the wound must be dressed prior to use of Game Ready).
- Who have an acute, unstable (untreated) fracture in the affected region.
- Who are children under 18 years old or patients who have cognitive disabilities or communication barriers, whether temporary (due to medication) or permanent.
- Who have a cardiac insufficiency or congestive heart failure (with associated edema in the extremities or lungs).
- Who have a localized unstable skin condition (e.g., dermatitis, vein ligation, gangrene, or recent skin graft) in the affected region.
- Who have erysipelas or other active infection in the affected region.

#### **Cryotherapy with the Game Ready System should be used only under the supervision of a licensed healthcare practitioner in patients:**

- Who have Raynaud's disease or cold hypersensitivity (cold urticaria).
- Who have hypertension or extreme low blood pressure.
- Who have diabetes.
- Who have compromised local circulation or neurologic impairment (including paralysis or localized compromise due to multiple surgical procedures) in the affected region.
- Who have a localized unstable skin condition (e.g., dermatitis, vein ligation, gangrene, or recent skin graft) in the affected region.
- Who have rheumatoid arthritis in the affected region.
- Who are children under 18 years old or patients who have cognitive disabilities or communication barriers, whether temporary (due to medication) or permanent.



**WARNING:** To comply with California Proposition 65, the following warning has been included: This product can expose you to chemicals including cadmium, chromium, lead, polybrominated biphenyls or mercury, which are known to the State of California to cause cancer or reproductive toxicity. For more information go to [www.p65warnings.ca.gov](http://www.p65warnings.ca.gov).

## CAUTIONS

- To avoid the risk of electrical shock, do not remove any panels from the Control Unit. Opening the case will void the Game Ready warranty. For all servicing and repair, in the U.S. call Game Ready Customer Service at 1.888.426.3732 (+1.510.868.2100); from outside of the U.S. please contact your local distributor.
- To avoid the risk of electrical shock, always turn off the system and disconnect the power line cord from its electrical outlet when not in use or before adding or emptying ice and water.
- Do not use any AC adapter other than that provided by Game Ready. Use of other adapters may result in electrical shock and will void the Game Ready warranty.
- To avoid damage to your product, do not operate the system without any water in the ice box.
- To avoid electrical shock, product malfunction or damage, never operate the system with damaged power cords or Connector Hoses, or other mechanical damage, or if the unit is otherwise not fully operational.
- To avoid potential damage to your product, do not pour hot water into the ice box. The system is not designed to operate, and has not been tested, with hot water.
- Do not use anything but ice and water in the ice box.
- To avoid damage to your product, do not pick up the Control Unit by the lid. Carry the Control Unit using the handle only.
- To avoid potential damage to your product, do not use other manufacturers' wraps with the Game Ready System.
- To avoid damage to your product, do not operate the Control Unit without a Connector Hose attached.
- To avoid injury, be careful not to trip over the system's power cords and Connector Hose.
- Monitor hose and cord placement when in use. Store hoses and cords when not in use to avoid potential of strangulation.
- Keep the system, including hoses and cords, away from children and pets.
- Use caution when handling small parts to reduce any possibility of swallowing or inhalation
- The GRPro 2.1 Control Unit is a technical medical device. To avoid damage to your product, handle it with the same care as you would a laptop computer. Do not drop it, kick it or otherwise abuse it unnecessarily. Such abuse will void all Game Ready warranties. Do not place the AC Adapter or Battery Pack inside the ice box for storage or transport.



- This symbol on the Control Unit or its packaging means that this product must not be disposed of with your household waste. To learn where to drop off your electrical and electronic waste, please contact your local city/municipal waste disposal service office or contact Game Ready for assistance.
- There are no special disposal requirements for the Wraps.

## SPECIFICATIONS

Size: 16.25" length x 7.75" width x 9.25" height (413 x 197 x 235) mm, not including Carry Bag

Weight: 7.3 lb. empty, approximately 18 lb. full of ice and water

Pressure level: cycles from 5mm Hg up to 75mm Hg

AC power: 100-240 V~, 50-60 Hz, 1.6A

DC input: 12V/2.5 A

- The maximum operating temperature of the equipment is between 33.8-104°F (1-40°C).
- The maximum operating altitude of the equipment is 9,843 feet (3,000 meters).
- The expected service life of the Control Unit is 5 years. The expected service life of the parts and accessories shipped with the Control Unit is 2 Years.

## UL CLASSIFICATION

### **Protection against electric shock:**

The GRPro 2.1 System is considered to be Class I (protective earth) when connected to the FSP Group, Inc. model FSP 030-RCAM power supply and Class II when connected to the Mega MDM-030-A120-5396 power supply.

The MDM-030-A120-5396 power supply is intended for home use. The FSP 030-RCAM power supply is not intended for home use.

### **Protection against harmful ingress of water:**

This product provides ordinary protection against ingress of water. When used with the MDM-030-A120-5396 power supply the device is classified to an IP22 rating, which is a protection against dripping water.

### **Pollution degree classification:**

This product is classified as Pollution degree 2.

### **Degree of safety in the presence of flammable anesthetics or oxygen:**

Not suitable for use in an oxygen enriched environment or in the presence of flammable anesthetics.

### **Electromagnetic interference:**

This equipment has been tested and found to comply with the limits for medical devices in IEC 60601-1-2:2007 and IEC 60601-1-2:2014. These limits are designed to provide reasonable protection against harmful interference in a typical medical installation.

This equipment generates, uses and can radiate radio frequency energy and, if not installed and used in accordance with the instructions, may cause harmful interference to other devices in the vicinity. However, there is no guarantee that interference will not occur in a particular installation.

If this equipment does cause harmful interference to other devices, which can be determined by turning the equipment off and on, the user is encouraged to try to correct the interference by one or more of the following measures:

- Reorient or relocate the receiving device.
- Increase the separation between the equipment. Connect the equipment into an outlet on a circuit different from that to which the other device(s) are connected.
- Consult the manufacturer or field service technician for help.

The device is intended for use in orthopedic centers, therapy clinics, athletic training facilities, hospitals, nursing facilities, medical centers, as well as in patient homes. The device should not be used in an environment where the intensity of electromagnetic disturbance is high.

In the event the device experiences a loss of performance or degradation due to electromagnetic disturbance, the device is expected to continue to operate safely.

The device should not be used less than 30 cm (12 inches) away from any portable and mobile RF communications equipment.

## Electromagnetic Compatibility Information According to IEC/EN 60601-1-2

Table 1 for Emissions

GUIDANCE AND MANUFACTURER'S DECLARATION – ELECTROMAGNETIC EMISSIONS		
The GRPro 2.1 is intended for use in the electromagnetic environment specified below. The customer or the user of the GRPro 2.1 should assure that it is used in such an environment.		
EMISSIONS TEST	COMPLIANCE	ELECTROMAGNETIC ENVIRONMENT – GUIDANCE
RF emissions CISPR 11	Group 1	The GRPro 2.1 uses RF energy only for its internal function. Therefore, its RF emissions are very low and are not likely to cause any interference in nearby electronic equipment.
RF emissions CISPR 11	Class B	The GRPro 2.1 is suitable for use in all establishments, including domestic establishments and those directly connected to the public low-voltage power supply network that supplies buildings used for domestic purposes.
Harmonic emissions IEC 61000-3-2	Class A	
Voltage fluctuations/ flicker emissions IEC 61000-3-3	Complies	

SUPERSEDED

**Table 2 for Transient Electromagnetic Immunity**

GUIDANCE AND MANUFACTURER'S DECLARATION – ELECTROMAGNETIC IMMUNITY			
The GRPro 2.1 is intended for use in the electromagnetic environment specified below. The customer or the user of the GRPro 2.1 should assure that it is used in such an environment.			
IMMUNITY TEST	IEC 60601 TEST LEVEL	COMPLIANCE LEVEL	ELECTROMAGNETIC ENVIRONMENT – GUIDANCE
Electrostatic discharge (ESD) IEC 61000-4-2	± 6 kV contact ± 8 kV air	± 6 kV contact ± 8 kV air	Floors should be wood, concrete or ceramic tile. If floors are covered with synthetic material, the relative humidity should be at least 30%.
Electrical fast transient/burst IEC 61000-4-4	± 2 kV for power supply lines ± 1 kV for input/output lines	± 2 kV for power supply lines ± 1 kV for input/output lines	Mains power quality should be that of a typical commercial or hospital environment.
Surge IEC 61000-4-5	± 1 kV line(s) to line(s) ± 2 kV line(s) to earth	± 1 kV line(s) to line(s) ± 2 kV line(s) to earth	Mains power quality should be that of a typical commercial or hospital environment.
Voltage dips, short interruptions and voltage variations on power supply input lines IEC 61000-4-11	<5% $U_T$ (>95% dip in $U_T$ ) for 0.5 cycle 40% $U_T$ (60% dip in $U_T$ ) for 5 cycles 70% $U_T$ (30% dip in $U_T$ ) for 25 cycles <5% $U_T$ (>95% dip in $U_T$ ) for 5 s	<5% $U_T$ (>95% dip in $U_T$ ) for 0.5 cycle 40% $U_T$ (60% dip in $U_T$ ) for 5 cycles 70% $U_T$ (30% dip in $U_T$ ) for 25 cycles <5% $U_T$ (>95% dip in $U_T$ ) for 5 s	Mains power quality should be that of a typical commercial or hospital environment. If the user of the GRPro 2.1 requires continued operation during power mains interruptions, it is recommended that the GRPro 2.1 be powered from an uninterruptible power supply or a battery.
Power frequency (50/60 Hz) magnetic field IEC 61000-4-8	3 A/m	3 A/m	Power frequency magnetic fields should be at levels characteristic of a typical location in a typical commercial or hospital environment.
NOTE $U_T$ is the AC mains voltage prior to application of the test level.			

**Table 3 for RF Electromagnetic Immunity**

GUIDANCE AND MANUFACTURER'S DECLARATION – ELECTROMAGNETIC IMMUNITY			
The GRPro 2.1 is intended for use in the electromagnetic environment specified below. The customer or the user of the GRPro 2.1 should assure that it is used in such an environment.			
IMMUNITY TEST	IEC 60601 TEST LEVEL	COMPLIANCE LEVEL	ELECTROMAGNETIC ENVIRONMENT – GUIDANCE
Conducted RF IEC 61000-4-6	3 Vrms 150 kHz to 80 MHz	3Vrms	<p>Portable and mobile RF communications equipment should be used no closer to any part of the GRPro 2.1, including cables, than the recommended separation distance calculated from the equation applicable to the frequency of the transmitter.</p> <p><b>Recommended separation distance</b>  <math>d = 1.2 \sqrt{P}</math> 80 MHz to 800 MHz</p>
Radiated RF IEC 61000-4-3	3 V/m 80 MHz to 2.5 GHz	3 V/m	<p><math>d = 1.2 \sqrt{P}</math> 80 MHz to 800 MHz  <math>d = 2.3 \sqrt{P}</math> 800 MHz to 2.5 GHz</p> <p>where <math>P</math> is the maximum output power rating of the transmitter in watts (W) according to the transmitter manufacturer and <math>d</math> is the recommended separation distance in meters (m).</p> <p>Field strengths from fixed RF transmitters, as determined by an electromagnetic site survey,<sup>a</sup> should be less than the compliance level in each frequency range.<sup>b</sup> Interference may occur in the vicinity of equipment marked with the following symbol:</p> 
<p>NOTE 1 At 80 MHz and 800 MHz, the higher frequency range applies.</p> <p>NOTE 2 These guidelines may not apply in all situations. Electromagnetic propagation is affected by absorption and reflection from structures, objects and people.</p>			
<p><sup>a</sup> Field strengths from fixed transmitters, such as base stations for radio (cellular/cordless) telephones and land mobile radios, amateur radio, AM and FM radio broadcast and TV broadcast cannot be predicted theoretically with accuracy. To assess the electromagnetic environment due to fixed RF transmitters, an electromagnetic site survey should be considered. If the measured field strength in the location in which the GRPro 2.1 is used exceeds the applicable RF compliance level above, the GRPro 2.1 should be observed to verify normal operation. If abnormal performance is observed, additional measures may be necessary, such as re-orienting or relocating the GRPro 2.1.</p> <p><sup>b</sup> Over the frequency range 150 kHz to 80 MHz, field strengths should be less than 3 V/m.</p>			

**Table 4 for RF Immunity**

<b>RECOMMENDED SEPARATION DISTANCES BETWEEN PORTABLE AND MOBILE RF COMMUNICATIONS EQUIPMENT AND THE GRPRO 2.1</b>			
The GRPro 2.1 is intended for use in an electromagnetic environment in which radiated RF disturbances are controlled. The customer or the user of the GRPro 2.1 can help prevent electromagnetic interference by maintaining a minimum distance between portable and mobile RF communications equipment (transmitters) and the GRPro 2.1 as recommended below, according to the maximum output power of the communications equipment.			
RATED MAXIMUM OUTPUT POWER OF TRANSMITTER <i>W</i>	SEPARATION DISTANCE ACCORDING TO FREQUENCY OF TRANSMITTER		
	150 KHZ TO 80 MHZ $d = 1.2 \sqrt{P}$	80 MHZ TO 800 MHZ $d = 1.2 \sqrt{P}$	800 MHZ TO 2.5 GHZ $d = 2.3 \sqrt{P}$
0.01	0.12	0.12	0.23
0.1	0.38	0.38	0.73
1	1.2	1.2	2.3
10	3.8	3.8	7.3
100	12	12	23
For transmitters rated at a maximum output power not listed above, the recommended separation distance <i>d</i> in meters (m) can be estimated using the equation applicable to the frequency of the transmitter, where <i>P</i> is the maximum output power rating of the transmitter in watts (W) according to the transmitter manufacturer. NOTE 1: At 80 MHz and 800 MHz, the separation distance for the higher frequency range applies. NOTE 2: These guidelines may not apply in all situations. Electromagnetic propagation is affected by absorption and reflection from structures, objects and people.			

**WARNINGS:**

**Medical Electrical Equipment needs special precautions regarding EMC and needs to be installed and put into service according to the EMC information provided in the User's Manual.**

**Portable and mobile RF communications equipment can affect Medical Electrical Equipment.**

**The GRPro 2.1 System has to be powered with the AC adapter FSP Group Inc. model FSP 030-RCAM or Mega MDM-030-A120-5396 power supply in order to be compliant with IEC/EN 60601-1-2 section 6.1 and 6.2.**

**The use of accessories, transducers and cables other than those specified and sold by the manufacturer of the GRPro 2.1 System as replacement parts for internal components may result in increased emissions or decreased immunity of the medical electrical system.**

**The GRPro 2.1 System should not be used adjacent to or stacked with other equipment. If adjacent or stacked use is necessary, the GRPro 2.1 System should be observed to verify normal operation in the configuration in which it will be used.**



**WARNING:** The essential performance of the GRPro 2.1 System is:

**Pneumatic Compression Cycles:**

- High: cyclic 5-75mm Hg
- Med: cyclic 5-50 mm Hg
- Low: cyclic 5-15 mm Hg
- NO Pressure: Wrap shall be vented to atmosphere
- Air Pressure Accuracy:  $\pm 10$  mm Hg

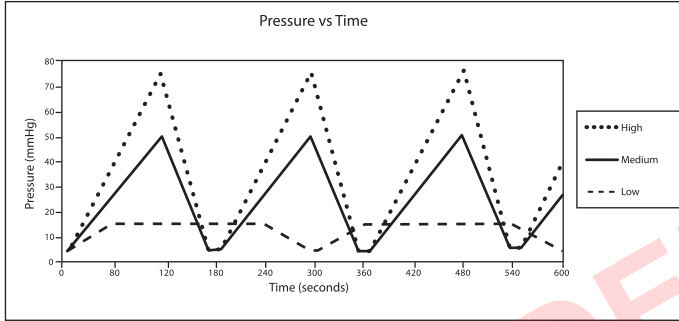













The cooling temperature of the circulating ice water will be adjustable between 34°F (1°C) and 50°F (10°C) as long as the ice water in the ice box is supplied with sufficient amount of ice.

- Water Temperature Accuracy:  $\pm 4$  °F ( $\pm 2.2$  °C)





SUPERSEDED

## TROUBLESHOOTING

ERROR	WHAT DOES IT MEAN?	WHAT CAN I DO?
 <span style="font-size: 2em; font-weight: bold;">01</span>	<p><b>Air Pressure Sensor:</b> The Control Unit has detected a problem calibrating the air pressure circuit on start-up.</p>	<ul style="list-style-type: none"> <li>• This is most likely to occur if you have restarted the system with an inflated Wrap attached.</li> <li>• Detach the Wrap, pressing it flat to expel the air accumulated inside and try again.</li> </ul>
 <span style="font-size: 2em; font-weight: bold;">02</span>	<p><b>Self-Test Error – Air Pump:</b> The Control Unit has detected an electronic problem in the air circuit on start-up.</p>	<ul style="list-style-type: none"> <li>• Disconnect the Wrap from the Control Unit.</li> <li>• Turn the Control Unit off and on again without a Wrap connected.</li> <li>• Reconnect the Wrap and resume treatment.</li> <li>• If the problem persists, contact Customer Service.</li> </ul>
 <span style="font-size: 2em; font-weight: bold;">04</span>	<p><b>Dry Pump:</b> The Control Unit has detected a dry pump. In order to prevent possible damage to the fluid pump, the unit will stop therapy.</p>	<ul style="list-style-type: none"> <li>• Be sure you are using ATX Series Heat Exchangers.</li> <li>• Note that if you are using new Wraps, the water in the reservoir may have been depleted and causing this error. Make sure there is adequate water in the reservoir based on the fill line indicator label. Refer to instructions for priming a Wrap below.</li> <li>• Verify that the ice box filter is not clogged (refer to filter maintenance instructions on page 14).</li> <li>• Make sure there are no kinks in the Wrap or Connector Hose.</li> <li>• Turn the Control Unit off and on again.</li> <li>• Disconnect and reconnect the hose from the Control Unit and the Wrap, verifying that an audible “click” is heard at both connection points.</li> <li>• Prime the Wrap using the following steps:               <ul style="list-style-type: none"> <li>- Select “Off” (No Pressure).</li> <li>- Attach the hose to the unit and the Wrap.</li> <li>- Lay the Wrap open and flat next to or lower than the Control Unit (not on the body).</li> <li>- Run the system for 2 minutes.</li> </ul> </li> <li>• Prime the Control Unit using the following steps:               <ul style="list-style-type: none"> <li>- Disconnect the hose from the Control Unit.</li> <li>- Now, look at the Wrap connection location on the Control Unit. On the top valve, push the white prong in so that it is flush with the metal connector.</li> <li>- Make sure you are not fully covering the opening in the prong.</li> <li>- Push start, and water should squirt out of the valve.</li> <li>- Restart the system.</li> </ul> </li> </ul>
 <span style="font-size: 2em; font-weight: bold;">06</span>	<p><b>Over Pressure:</b> Indicates that the Control Unit has exceeded the target air pressure.</p>	<ul style="list-style-type: none"> <li>• Turn the Control Unit off and back on.</li> <li>• Make sure the Wrap is applied securely.</li> <li>• Do not make sudden movements during treatments. Rapid shifting in position may produce a quick change in pressure in the Wrap and cause this error.</li> </ul>

ERROR	WHAT DOES IT MEAN?	WHAT CAN I DO?
 	<p><b>Under Pressure:</b> The Control Unit can't reach its target maximum compression. This often indicates that there is a leak in the pneumatic compression circuit, either in the Connector Hose, Wrap or Control Unit. Or it may occur because the hook and loop fastener on your Wrap has worn out.</p>	<ul style="list-style-type: none"> <li>• Make sure the Wrap is applied securely.</li> <li>• Try using a different Wrap and Hose to isolate which component may be producing the error. For example, an error which occurs with a Shoulder Wrap but not a Knee Wrap may indicate that the Shoulder Wrap is causing the error: not the Control Unit.</li> <li>• If using a Dual Hose, make sure you have two Wraps attached.</li> </ul>
 	<p><b>Deflation Error:</b> The Control Unit has detected that the Wrap has not properly deflated.</p>	<ul style="list-style-type: none"> <li>• Turn the Control Unit off.</li> <li>• If there is air left in the Wrap, disconnect the Wrap from the Connector Hose and manually deflate the Wrap by applying pressure to it.</li> <li>• Reconnect the Hose to the Wrap and reapply the Wrap to the body.</li> <li>• Turn the Control Unit on and press play/pause.</li> <li>• Make sure the Wrap is applied securely against the body.</li> <li>• If possible, try using a different Wrap and Hose to isolate which component may be producing the error. For example, an error which occurs with a Shoulder Wrap but not a Knee Wrap may indicate that the Shoulder Wrap is causing the error: not the Knee Wrap or Control Unit.</li> </ul>
 	<p><b>Pump Performance Error:</b> The Control Unit has determined that the fluid pump may be working too hard. This could be caused by ice or debris in the fluid circuit. In order to prevent possible damage to the fluid pump, the unit will stop therapy.</p>	<ul style="list-style-type: none"> <li>• Turn the Control Unit off and back on again.</li> <li>• Reapply the Wrap, making sure to follow all application instructions accompanying the Wrap.</li> <li>• Disconnect and reconnect the hose from the Control Unit and the Wrap, verifying that an audible "click" is heard at both connection points.</li> <li>• If that does not solve the problem turn the Control Unit off for 20 minutes (to let the pump cool down) before turning it on again to try again.</li> </ul>
 	<p><b>Low Flow:</b> Control Unit has detected something blocking the water flow.</p>	<ul style="list-style-type: none"> <li>• Be sure you are using ATX Series Heat Exchangers.</li> <li>• Check all hose connections.</li> <li>• Disconnect and reconnect Wrap from Connector Hose.</li> <li>• Make sure there is water in the ice box.</li> <li>• Verify that the ice box filter is not clogged.</li> <li>• Make sure there are no kinks in the Wrap or Connector Hose.</li> <li>• Reapply the Wrap snugly, making sure to follow all application instructions accompanying the Wrap.</li> <li>• Turn the Control Unit off and on again.</li> <li>• Disconnect and reconnect the hose from the Control Unit and the Wrap.</li> </ul>

**Need more help with a problem?** In the U.S. call Game Ready Customer Service at 1.888.426.3732 (+1.510.868.2100); from outside of the U.S. please contact your local distributor.

ERROR	WHAT DOES IT MEAN?	WHAT CAN I DO?
 	<p><b>Self-Test Error – Fluid Circuit:</b> The Control Unit has detected an electronic problem in the fluid circuit on start-up.</p>	<ul style="list-style-type: none"> <li>• Turn off the Control Unit.</li> <li>• Turn the Control Unit back on and resume treatment.</li> <li>• If the problem persists, contact Customer Service.</li> </ul>
 	<p><b>Temperature Calibration Error:</b> The Control Unit has detected a failure in the Temperature Control circuit or is being operated outside of the advised temperature range (33.8-104 degrees Fahrenheit).</p>	<ul style="list-style-type: none"> <li>• Be sure you are operating the system within the advised temperature range of 33.8-104 degrees Fahrenheit and storing the system within the advised temperature range of 33-120 degrees Fahrenheit.</li> <li>• Turn the Control Unit off.</li> <li>• Fill the Control Unit with ice and water per the label instructions inside the reservoir.</li> <li>• Turn the unit back on again and push Play/Pause.</li> <li>• Repeat this process up to three times.</li> <li>• If the problem persists, contact Customer Service.</li> </ul>
	<p><b>Control Unit will not turn on:</b></p>	<ul style="list-style-type: none"> <li>• Press the power button. If no orange or green light is illuminated, make sure the AC Adapter is plugged into a working electrical outlet and all connections are secure. (Test outlet with another electrical device.)</li> <li>• Press the power button again. If the Control Unit still will not turn on, call Customer Service.</li> </ul>
	<p><b>Control Unit won't reach Target Temperature, or temperature is unstable:</b></p>	<p>The fill-line labels within the reservoir indicate an ice/water ratio that will assist the Control Unit in achieving the temperature you've specified using the Temperature Knob. If you have filled the Control Unit according to the fill-line labels and are still unable to achieve your desired target temperature, try the following steps:</p> <ul style="list-style-type: none"> <li>• If you are still unable to achieve <b>WARMER</b> temperatures, be sure the Temperature Knob is turned to full warm, use less ice, and reduce the amount of water if necessary.</li> <li>• If you are still unable to achieve <b>COLDER</b> temperatures, be sure the you are using ATX Series Heat Exchangers. Confirm that the Temperature Knob is set to full cold and that the reservoir is full of ice, replenishing frequently and stirring the reservoir to break up large formations of ice if necessary. Make sure there are no kinks in the Wrap or Connector Hose. Reapply the Wrap, making sure to follow all accompanying application instructions. Finally, if you still cannot achieve the coldest temperature desired, adding more water than what is indicated by the reservoir fill-line labels may also allow the Control Unit to reach colder temperatures. To achieve this effect, water may be added to the top of the ice level.</li> </ul> <p><b>CAUTION:</b> By overfilling the reservoir as in the last step, the temperature control feature of the system will not work and the Control Unit will be administering therapy at "full cold." Consult the Warnings on page 16 to make sure you take proper steps to minimize the risk of injury.</p>

## WARRANTY

### MANUFACTURER'S WARRANTY

CoolSystems warrants that the GRPro 2.1 Control Unit, if properly used, will be free from defects in material and workmanship for a period of two (2) years after the date the GRPro 2.1 Control Unit was purchased. If the GRPro 2.1 Control Unit, which is the subject of this Limited Warranty, malfunctions during the warranty period for reasons covered by this Limited Warranty, CoolSystems, at its options, will:

- REPAIR the GRPro 2.1 Control Unit OR
  - REPLACE the GRPro 2.1 Control Unit with another GRPro 2.1 Control Unit.
- THIS LIMITED WARRANTY AND ANY IMPLIED WARRANTIES THAT MAY EXIST UNDER STATE LAW APPLY ONLY TO THE ORIGINAL PURCHASER OF THE GRPRO 2.1 CONTROL UNIT AND ARE NON-TRANSFERABLE.

#### Extent of Limited Warranty

This limited warranty does not cover damages due to external causes, including, without limitation, accident, usage not in accordance with product instructions, misuse, neglect, alteration or repair.

#### How to Obtain Warranty Service

To obtain warranty service, in the U.S. call Game Ready Customer Service at 1.888.426.3732 (+1.510.868.2100); from outside of the U.S. please contact your local distributor. If you are not sure who the local distributor is, call Game Ready Customer Service at +1.510.868.2100 and we will refer you to one. You must have returned the Warranty Registration card to CoolSystems within thirty (30) days from the date of purchase to qualify for warranty service. If you qualify for warranty service from CoolSystems, you will be issued a Returned Material Authorization (RMA) number. When you return the GRPro 2.1 Control Unit to CoolSystems, you must write the RMA number on the outside of the package. CoolSystems will not accept returned GRPro 2.1 Control Units without an RMA number on the package. If you return the GRPro 2.1 Control Unit to CoolSystems, you must assume the risk of damage or loss during shipping. You must use the original packaging or the equivalent. CoolSystems may require you to verify in writing that you are the original purchaser of the GRPro 2.1 Control Unit. CoolSystems may elect to replace or repair the GRPro 2.1 Control Unit with either a new or reconditioned product. The returned product shall become CoolSystems' property upon receipt. The replacement GRPro 2.1 Control Unit is warranted under this written warranty and is subject to the same limitations and exclusions for the remainder of the original warranty period. THIS WARRANTY IS NOT TRANSFERABLE.

### WARRANTY LIMITATIONS AND EXCLUSIONS

THESE WARRANTIES REPLACE ALL OTHER WARRANTIES, EXPRESS OR IMPLIED INCLUDING, BUT NOT LIMITED TO, THE IMPLIED WARRANTIES OF MERCHANTABILITY AND FITNESS FOR A PARTICULAR PURPOSE. COOLSYSTEMS MAKES NO EXPRESS WARRANTIES BEYOND THOSE STATED HERE. COOLSYSTEMS DISCLAIMS ALL OTHER WARRANTIES, EXPRESS OR IMPLIED INCLUDING, WITHOUT LIMITATION, IMPLIED WARRANTIES OF MERCHANTABILITY AND FITNESS FOR A PARTICULAR PURPOSE. SOME JURISDICTIONS DO NOT ALLOW THE EXCLUSION OF IMPLIED WARRANTIES SO THIS LIMITATION MAY NOT APPLY TO YOU. ALL EXPRESS AND IMPLIED WARRANTIES ARE LIMITED IN DURATION TO THE LIMITED WARRANTY PERIOD. NO WARRANTIES APPLY AFTER THAT PERIOD. SOME JURISDICTIONS DO NOT ALLOW LIMITATIONS ON HOW LONG AN IMPLIED WARRANTY LASTS, SO THIS LIMITATION MAY NOT APPLY TO YOU.

## LIMITATIONS OF LIABILITY

COOLSYSTEMS' RESPONSIBILITY UNDER THIS, OR ANY OTHER WARRANTY, IMPLIED OR EXPRESS, IS LIMITED TO REPAIR OR REPLACEMENT, AS SET FORTH ABOVE. THESE REMEDIES ARE THE SOLE AND EXCLUSIVE REMEDIES FOR ANY BREACH OF WARRANTY. COOLSYSTEMS IS NOT RESPONSIBLE FOR DIRECT, SPECIAL, INCIDENTAL, OR CONSEQUENTIAL DAMAGES RESULTING FROM ANY BREACH OF WARRANTY OR UNDER ANY OTHER LEGAL THEORY INCLUDING, BUT NOT LIMITED TO, LOST PROFITS, DOWNTIME, GOODWILL, AND DAMAGE TO OR REPLACEMENT OF EQUIPMENT AND PROPERTY. SOME JURISDICTIONS DO NOT ALLOW THE EXCLUSION OR LIMITATION OF INCIDENTAL OR CONSEQUENTIAL DAMAGES, SO THE ABOVE LIMITATIONS OR EXCLUSIONS MAY NOT APPLY TO YOU. THIS LIMITED WARRANTY GIVES YOU SPECIFIC RIGHTS, AND YOU MAY ALSO HAVE OTHER RIGHTS THAT VARY FROM JURISDICTION TO JURISDICTION.

## WARRANTY REGISTRATION

The GRPro 2.1 Control Unit comes with a 2-year warranty from date of purchase. The Heat Exchanger, Connector Hose, AC Adapter, and Power Cord come with a 1-year warranty. In the case of a manufacturer's defect, the Wrap sleeve and sleeve accessories may be returned within 7 days of purchase.

## REGISTRATION

Please complete the Warranty Registration within 30 days for both the GRPro 2.1 Control Unit and the Wraps online at [www.gameready.com](http://www.gameready.com). You will need the following information to complete your Warranty Registration: **The Control Unit's model number (REF) and its serial number (SN)**. These numbers are located on the label on the bottom of the Control Unit. Simply go to [www.gameready.com](http://www.gameready.com), visit the Product Registration page, fill out the form and submit your information.

## EXTENDED WARRANTIES

Extended Warranties are available for the GRPro 2.1 System. For details and information, in the U.S. call Game Ready Customer Service at 1.888.426.3732 (+1.510.868.2100); from outside of the U.S. please contact your local distributor.

A list of current patent(s) covering Game Ready technology can be found at: [www.gameready.com/patents](http://www.gameready.com/patents).



EMERGO EUROPE  
Prinsessegracht 20  
2514 AP The Hague  
The Netherlands

EMERGO AUSTRALIA  
201 Sussex Street  
Darling Park  
Tower II, Level 20  
Sydney NSW 2000  
Australia



## REGISTRANT AND AGENT INFORMATION

Registrant/Manufacturer: CoolSystems, Inc.  
Registered Address: 1800 Sutter Street, Suite 500 Concord, CA 94520, USA  
Manufacturing Site Address: 1800 Sutter Street, Suite 500 Concord, CA 94520, USA  
Contact Details: +1.510.868.2100  
URL: [www.gameready.com](http://www.gameready.com)

Agent Name: Beijing Yongkangtai Technology Co., Ltd.  
After-sales Service: Beijing Yongkangtai Technology Co., Ltd.  
Address: No. 19 West Gucheng Street, R&D and Production Building, Block H,  
2nd Floor, Room 205, Shijingshan District, Beijing, China  
Contact Details: 010-68925005  
Fax: 010-68925008

Production Date and Expiration: See package

Registration Number:

Technical Requirements Number:

SUPERSEDED

SUPERSEDED

G A M E  R E A D Y<sup>®</sup>

 COOLSYSTEMS<sup>®</sup>, INC.  
DBA Game Ready<sup>®</sup>  
1800 Sutter Street, Suite 500  
Concord, CA 94520 USA  
1.888.GAMEREADY +1.510.868.2100  
[www.gameready.com](http://www.gameready.com)